

1

2

3

4

5

6

A

B

C

D

A

B

C

D

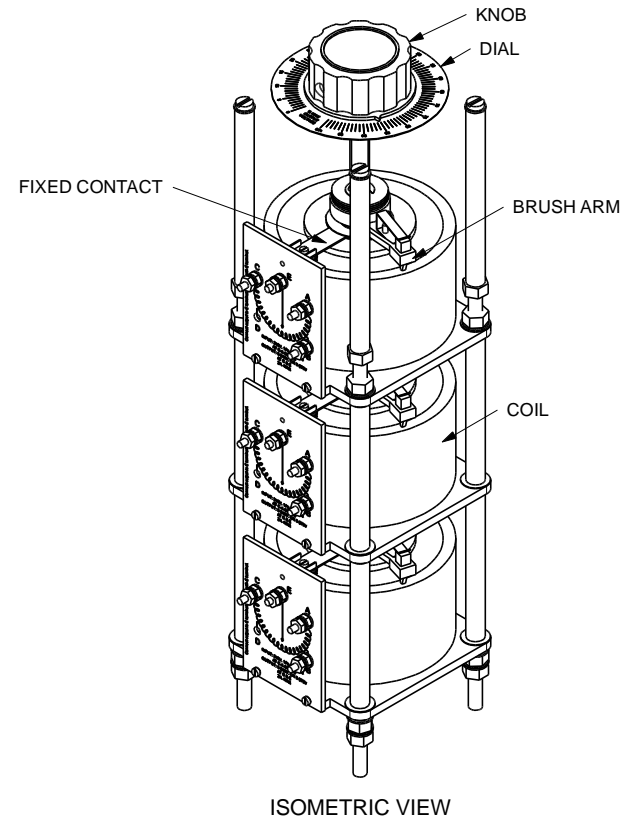
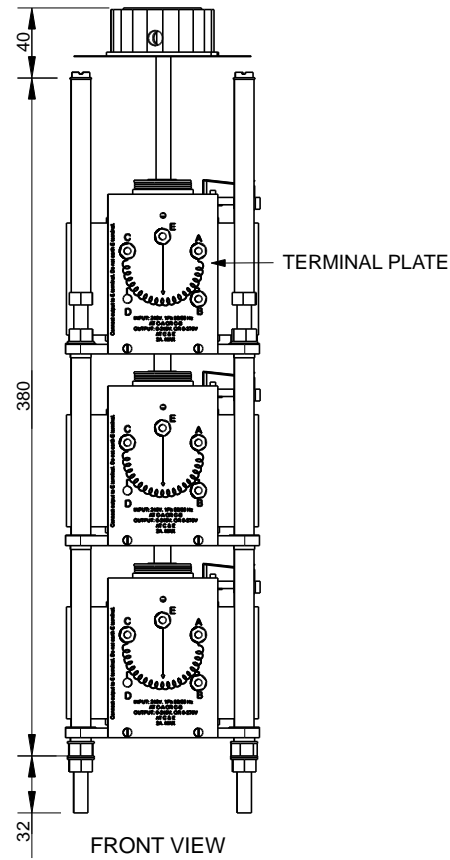
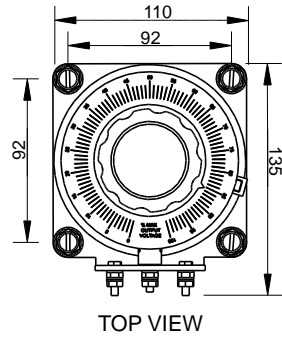

CLIENT:-

Drawn  
RK

Checked  
MR

Drawn Date  
15-5-2015

Approved By - Date  
MR 15-5-2015

Scale  
NTS



TITLE:- FLUSH / OPEN / BACK OF PANEL MOUNTING  
TYPE: 2F-3

DWG NO:- VAC/VAR/GA/28/52015

SHEET No: 1-1

1

2

3

4

5

6